

BRISTAN

Installation Instructions & User Guide

Please leave these instructions with the end user

Product Code: PS2 BAS C (D2)

Specifications

Dynamic Water Pressure (Bar)

Min: 0.3 Max: 5.0

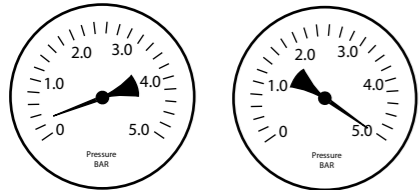

Maximum Static Pressure: 10.0 bar

Inlet Water Temperature

Cold Water Supply

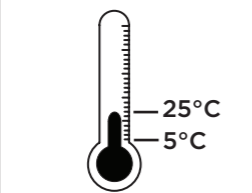

Min: 5°C Max: 25°C

Hot Water Supply

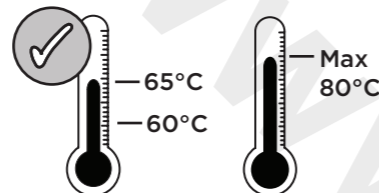

60-65°C Recommended
80°C Maximum

Inlet Connections

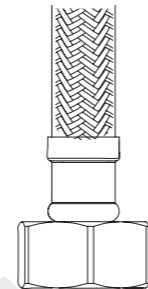

Flexible 1/2" BSP

Tools You'll Need

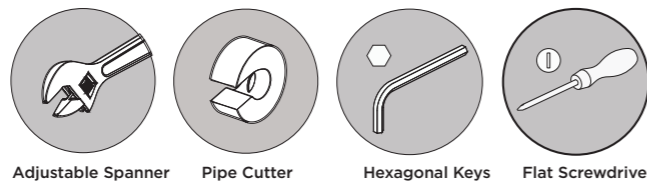

Adjustable Spanner Pipe Cutter Hexagonal Keys Flat Screwdriver

Flexible Connecting pipes

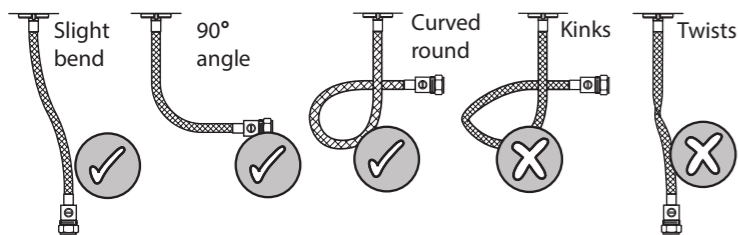

Pack Contents

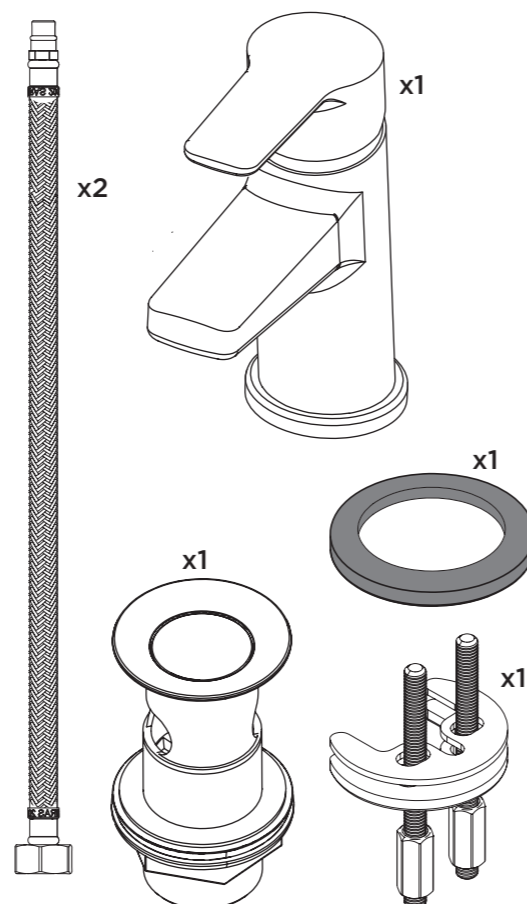

Prior to Installation

All products manufactured and supplied by Bristan are safe provided they are installed, used correctly and receive regular maintenance in accordance with these instructions.

This product has been tested to the Water Regulations Advisory Scheme (WRAS) and satisfies the requirements of the Water Supply (Water Fittings) Regulations 1999 and current bylaws.

For full Installation Requirements & Notes (IRN) please visit:

www.wras.co.uk/directory

Isolation valves must be fitted to the inlet water supplies to ensure ease of future maintenance.

Before installing these taps the water supply must be thoroughly flushed in order to remove any swarf, solder etc from the pipework.

Installation - Basin Mixer

1

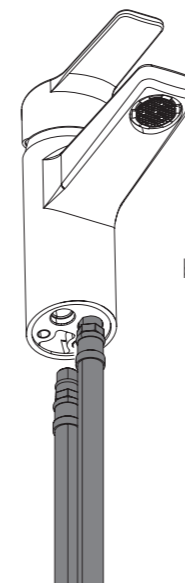

Screw the flexi tails into the bottom of the mixer body by **hand only**.

(DO NOT OVERTIGHTEN)

2

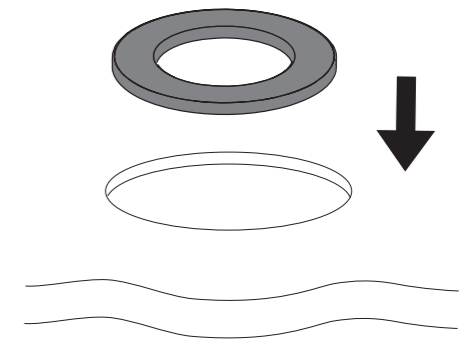

Place the plinth over the hole in the basin ensuring that the washer is fitted between the plinth and the basin.

3

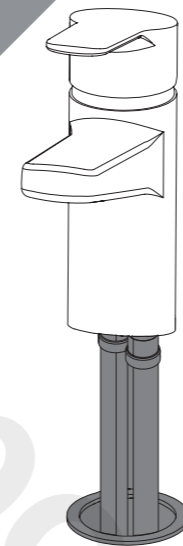

Feed the flexi tails through the hole in the basin.

4

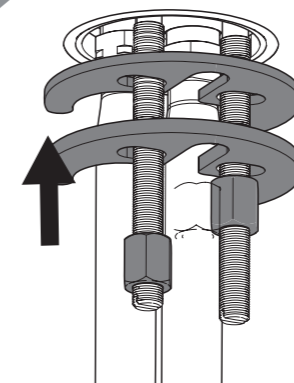

Slide the 'C' shaped rubber washer and the 'C' shaped metal washer onto the fixing rods up to the underside of the basin.

Secure the mixer in place by tightening the fixing nuts onto the fixing rod against the 'C' shaped metal washer.

5

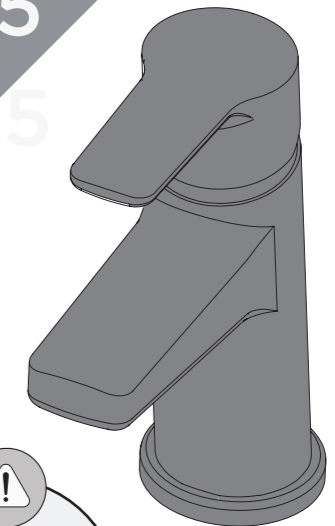

Connect the flexible tails to the water supplies system.

Turn on the mains water supply and check all joints and connections for leaks!

Installation- Clicker Waste

1

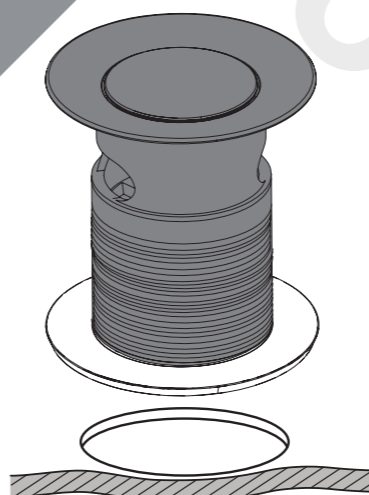

Fit the waste body and rubber washer into the basin

2

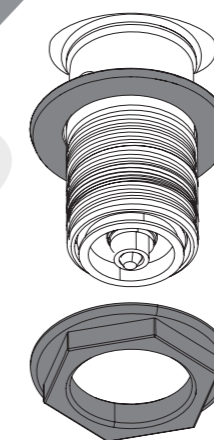

Place shaped rubber washer under the basin & secure waste by tightening backnut

Operation-Clicker Waste

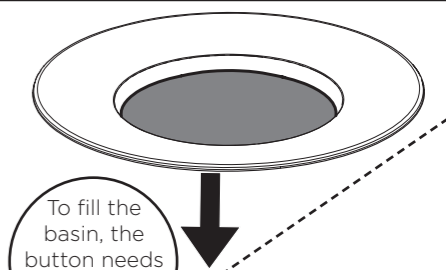

To fill the basin, the button needs to be pressed down

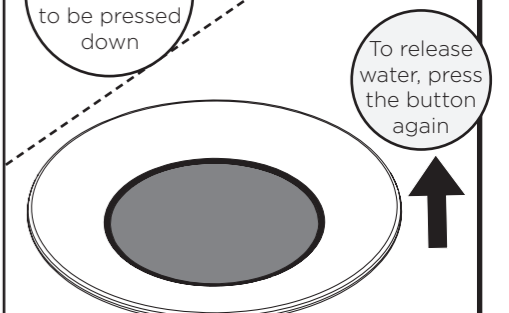

To release water, press the button again

Operation

Temperature Control

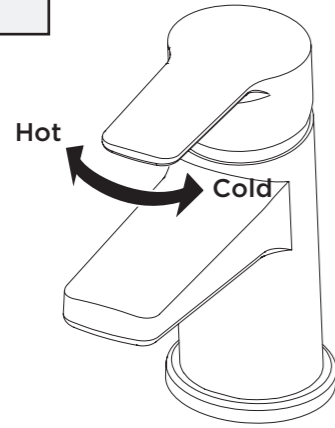

Flow Control

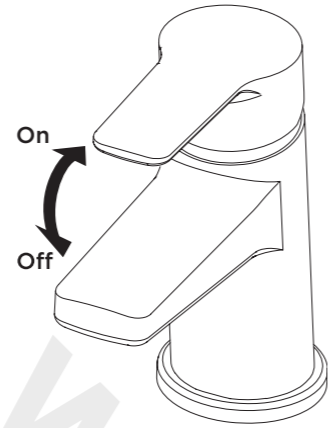

Maintenance - Cartridge Cleaning

1

IMPORTANT
Isolate the water supply before starting!

Remove the cap and loosen the grub screw and remove the handle

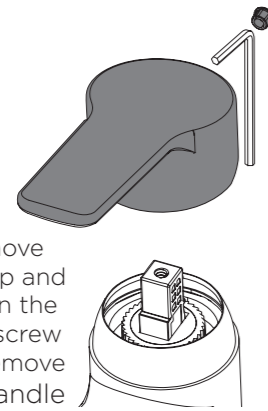

2

Unscrew the shroud and the retaining ring using an adjustable spanner

2.5 mm

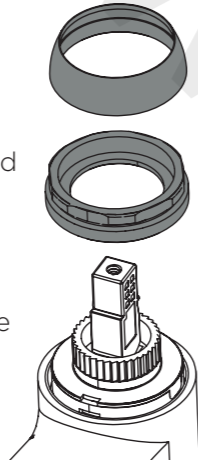

3

Remove the cartridge and soak in suitable descaler.

Rinse the cartridge with cold water, dry off and apply WRAS approved silicon grease

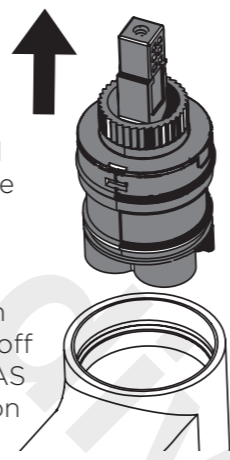

4

Replace the cartridge back to into the body. Tighten the cartridge retaining nut using a suitable spanner

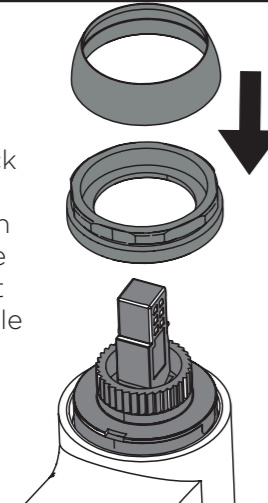

5

Secure the shroud back on the tap and apply handle, tighten the grub screw

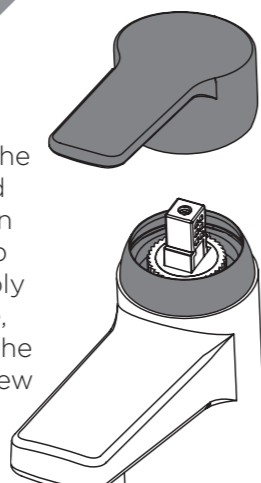

6

Turn the water supply on.

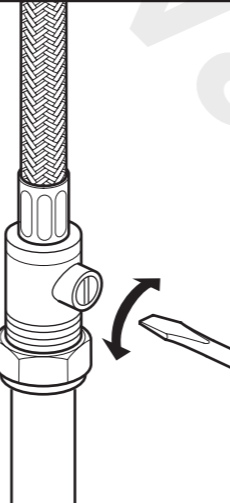

Maintenance - Flow Straightener

7

Use a key (not supplied) to remove the flow straightener and soak in the descaler.

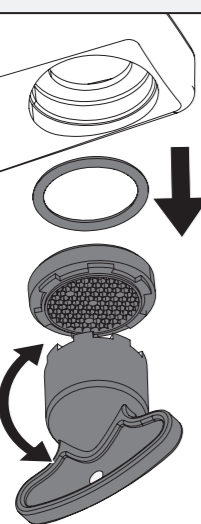

8

Rinse and replace into spout using key to secure.

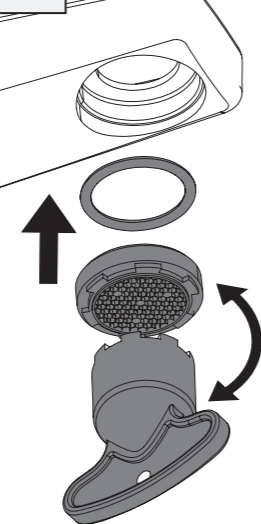

Spares

To replace spare parts for your basin mixer why not scan the QR code and search for your product



General Cleaning

Your fitting has a high quality finish and should be treated with care to preserve the visible surfaces.

All surfaces will wear if not cleaned correctly, the only safe way to clean your mixer tap is to wipe with a soft damp cloth. Stains can be removed using washing up liquid. All bath cleaning powders and liquids will damage the surface of your fitting, even the non-scratch cleaners.

Note: Never use abrasive detergents or disinfectants or those containing alcohol, hydrochloric acid or phosphoric acid.

Troubleshooting

Symptom	Cause(s)	Remedy	
No flow or low flow rate	Partially closed isolation valve.	Open isolation valve.	
	Instantaneous water heater cycles on and off as flow rate or pressure is too low.	Increase water flow rate or pressure through system.	
	Head of water is below the minimum distance required.	Refer to the specification for the minimum distance required	
	Hot or cold water being drawn off elsewhere causing pressure changes or instantaneous boiler temperature changes.	Do not use other water outlets when using the taps.	
	Airlock or partial blockage in the supply pipework.	Flush through pipework to ensure removal of debris and any airlocks.	
	Water supply failure, please check below:	Investigate water supply. Check your plumbing and heating systems for any faults.	
	When handle is in Hot Position		fault on the hot water supply. Cold water supply will still continue to run
	When handle is in Mixed position		fault on either hot and/or cold water supply. Tap will not run in this position due to inability to mix water
	When handle is in Cold position	fault on the cold water supply. Hot water will still continue to run.	
	Water dripping from taps	This is normal for a short time after using the taps.	This is caused by capillary action, the build up of water in the tap body.
If water continues to drip, possibly due to the ceramic disc valves/cartridge		Refer to the section: Maintenance - Cleaning/ Replacing Cartridge	
Taps do not turn on	Closed isolation valve.	Open isolation valve.	
	Mains water supply turned off.	Turn on mains water supply.	

At Bristan, we want to make things as easy as possible for our customers. That's why we offer solid guarantees on all our products, effective from the date of purchase, to give you peace of mind.

To start your free guarantee simply scan the QR code and register your product. Alternatively visit www.bristan.com/register.

For any other queries, please call our Customer Service on 0330 026 6273 where our expert team of advisors will be able to offer you any help and advice.

For full guarantee terms and conditions visit www.bristan.com/guarantees.



We Know & We Care